



*Instructions Manual / Manual de Instrucciones*



*Professional Blender/ Licuador Profesional*

*Model / Modelos*

***LI-2.0 BAR***

*Office*  
Phone: 1-800-503-7534 / 305-868-1603  
Fax: 305-866-2704

sales@skyfood.us - www.skyfood.us

**TOLL FREE 1-800-503-7534**



# SUMMARY / INDICE

1. ENGLISH \_\_\_\_\_ 01

2. ESPAÑOL \_\_\_\_\_ 13



***LI-2,0 BAR***

# SUMMARY

<b>1. Introduction</b>	<b>02</b>
1.1 Safety	02
1.2 Main Components	03
1.3 Technical Characteristics	03
<b>2. Installation and Pre-Operation</b>	<b>04</b>
2.1 Installation	04
2.2 How to assemble the blender Cup	04
2.3 What to do and what not to do with your Professional Blender	04
<b>3. Operation</b>	<b>05</b>
3.1 Starting	05
3.2 Feeding Procedures	06
3.3 Cleaning	06
<b>4. General Safety Rules</b>	<b>08</b>
4.1 Basic Operation Practices	08
4.2 Cautions to Observe before turning the machine on	09
4.3 Routine Inspection	09
4.4 Operation	10
4.5 After finishing the work	10
4.6 Maintenance Operation	10
4.7 Warnings	10
<b>5. Problems Analysis and Resolutions</b>	<b>10</b>
5.1 Problems, Causes and Solutions	10
5.2 Electric Diagram	12
<b>6. General Advises</b>	<b>10</b>

# 1. Introduction

## 1.1 Main Safety Precautions

When using this equipment bear in mind some basic Safety Precautions

- 1.1.1 Read carefully all the instructions
- 1.1.2 To avoid electric shock risk and damages to the equipment , never operate it wearing wet clothes or shoes , resting on wet surfaces , nor plunge it in water or any other liquid , and do not throw water directly on the equipment.
- 1.1.3 Any equipment shall always be operated under supervision , principally when used near children
- 1.1.4 Unplug the equipment from electric source when : it is not being used, before cleaning or before to insert or remove accessories, and when any maintenance or service is to be done .
- 1.1.5 Do not operate any equipment having a damaged cord or plug .The cord shall not rest on hot surfaces nor on table edges
- 1.1.6 If your equipment is failing or has been dropped or damaged any way, take it to Technical Assistance to repair, or for electric or mechanical adjustment .
- 1.1.7 Using accessories not recommended by the manufacturer, may cause personal injuries .
- 1.1.8 While operating the equipment keep the hands or any other tool away from any parts in movement to avoid personal injuries or damage to the equipment
- 1.1.9 Blades are sharp , be aware .
- 1.1.10 Before to start the blender always place the lid
- 1.1.11 Always hold the bowl while the blender is running, If the bowl loosen turn immediately OFF the blender, empty the bowl and strongly screw it back .
- 1.1.12 When adding hot liquids , withdraw the transparent cap, and be careful to hold back your hands to avoid possible burnings .
- 1.1.13 To avoid accidents or personal injuries, never place on the blender the central bearing with its knife , without to have the bowl duly in place and firmly screwed.
- 1.1.14 For your safety, the temperature of the processed products shall not exceed 40° Celsius / 104° Fahrenheit.

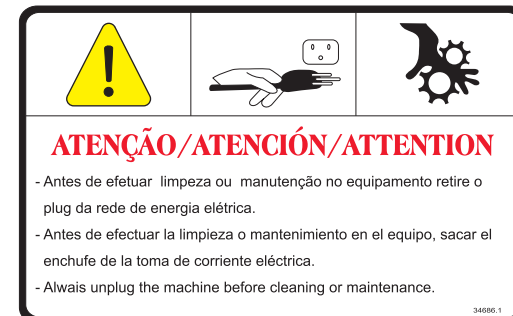

## 1.2 Main Components

All components of this machine were designed and made to its proper function according to pattern tests and experience of Siemens.

### Picture 01

- 01 - Bowl
- 02 - Lid
- 03 - Motor Housing
- 04 - ON/OFF Switch
- 05 - Cap
- 06 - Timer Knob
- 07 - Pulse Switch



## 1.3 Technical Characteristics

Table - 01

CHARACTERÍSTICS	U.M.	LI-2,0 BAR
Voltage	[V]	110 ou 220 *
Frequency	[Hz]	50 / 60
Power Rating	[W]	800
Consumption	[kW/h]	0,8
Height	[Inches]	16 ½"
Width	[Inches]	7 7/8"
Depth	[Inches]	7 7/8"
Net Weight	[lb]	5,5
Gross Weight	[lb]	8.8
Cup Maximum Capacity	[L]	2,0
Rotation	[rpm]	18000

(\*) Voltage will be only the one indicated on motor characteristics label.

### Warranty Registration



### Questions about how to complete this form?

Call 1-800-503-7534 / 305-868-1603

### Return completed form to:

SKYFOOD EQUIPMENT LLC  
11900 Biscayne Blvd. Suite 512  
North Miami, FL 33181 - USA

### Or fax form to:

305-866-2704

### IMPORTANT:

Only for products of the trademark: and

### User Details

\* Contact Person: \_\_\_\_\_

### \* Business type:

- |  |   |
|--|---|
| <input type="checkbox"/> Bakery and Bagel Operations                   | <input type="checkbox"/> Mass Merchandiser with Grocery                   |
| <input type="checkbox"/> Bakery (Associated with Restaurant)           | <input type="checkbox"/> Mass Merchandiser with NO Grocery                |
| <input type="checkbox"/> Bowling Center                                | <input type="checkbox"/> Meat Packer and Purveyor                         |
| <input type="checkbox"/> Business and Industry In-House Feeding        | <input type="checkbox"/> Other Business that prepares or serves food      |
| <input type="checkbox"/> Butcher                                       | <input type="checkbox"/> Other Business that sells but doesn't serve food |
| <input type="checkbox"/> Catering                                      | <input type="checkbox"/> Pizza (Dine In / Carry Out)                      |
| <input type="checkbox"/> Club Stores                                   | <input type="checkbox"/> Restaurants (Independent / Chain)                |
| <input type="checkbox"/> Convenience Store                             | <input type="checkbox"/> School   |
| <input type="checkbox"/> Country Club                                  | <input type="checkbox"/> Stadiums / Coliseum                              |
| <input type="checkbox"/> Delicatessen (Chain / Restaurant)             | <input type="checkbox"/> Supermarket / Grocery                            |
| <input type="checkbox"/> Delicatessen (Independent and Non-Restaurant) | <input type="checkbox"/> Theme Park                                       |
| <input type="checkbox"/> Food Store                                    | <input type="checkbox"/> University / College                             |
| <input type="checkbox"/> Government                                    | <input type="checkbox"/> Vineyard / Winery                                |
| <input type="checkbox"/> Hospital                                      | <input type="checkbox"/> Warehouse Clubs                                  |
| <input type="checkbox"/> Lodging                                       | <input type="checkbox"/> Wholesale Baking Operation (Non-Institutional)   |

\* Company Name: \_\_\_\_\_

\* Address: \_\_\_\_\_

\* City: \_\_\_\_\_

\* State: \_\_\_\_\_ \* Zip Code: \_\_\_\_\_

\* Phone: \_\_\_\_\_ Fax: \_\_\_\_\_

\*\* E-mail: \_\_\_\_\_

Web page: \_\_\_\_\_

I would like to join the Mail List.

I would like to join the E-mail List.

### Product Details

\* Product Commercial Item: \_\_\_\_\_

The Product Commercial Item can be found on the machine Product Identification Label.

\* Serial Number: \_\_\_\_\_ \* Confirm Serial Number: \_\_\_\_\_

This information, the Product Serial Number, can also be found on the machine Product Identification Label.

\* Proof of Purchase:  Yes  
 No

\* Purchased On: \_\_\_\_\_ / \_\_\_\_\_ / \_\_\_\_\_ (mm / dd / yyyy)

\* Purchased From: \_\_\_\_\_  
Company Name

\* Indicates required field.

\*\* Indicates required field, not mandatory by Fax.

**IMPORTANT**  
Metalúrgica Siemens is **NOT RESPONSIBLE** for any damage caused when using **NOT ORIGINAL** spare parts.

## 2. INSTALLATION and PRE OPERATION

### 2.1 Installation

To achieve a good performance the Blender shall be installed on a steady and flat surface about 850 mm above the floor .

The Blender has been designed for 110 V or 220 V voltages . Check the voltage , to be sure the electric source has the same voltage indicated on the label placed on the cord .

The cord plug has three round pins, one of them is ground. It is mandatory to have the three pins properly connected to the power source .

**Pic.02**

### 2.2 How to assemble the Blender Cup

**2.2.1** – Put Rubber Sealing Ring N° 01 on Central Bearing N° 02, Pic. (02)

**2.2.2** – Fit the Central Bearing N° 02 + Rubber Sealing Ring N° 01 on the Cup Base N° 03, Pic. (02)

**2.2.3** – Screw the Cup N° 4 on the Cup Base N° 03, Pic. (02).

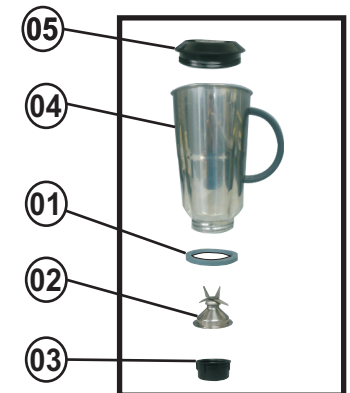

### 2.3 PRE OPERATION

What to do and what not to do with your Milk Shake Mixer.

#### **You have to:**

.... Check the voltage before to switch ON the blender. Use only the voltage indicated on the blender base .

.... Check if the machine is firm The supporting surface must be clean and dry to avoid water or dirt to be aspired along with the air .

.... Put liquid ingredients inside the cup first, then put solid ingredients.

.... Cut all fruits, vegetables, boiled meat, fish or sea food in pieces of up to 2cm size. Cut cheese in pieces of up to 1,5cm size.

.... Use a rubber spatula to push ingredients into the liquid . **ONLY** with machine **SWITCHED OFF**.

.... Place the Lid on top of the Cup firmly before switching the machine ON and keep your hand over the lid while the blender motor is working.

....Remove the thick sauces, butter, mayonnaise and similar consistence products removing the blender base and pushing the mixture through the cup lower side .

....rop the liquid or semi-liquid mixtures, straight into the blender cup.

.... Never put hot ingredients inside the cup, let them cool down first.

#### **You should not:**

... expect your blender to replace any other kitchen appliance. It is not supposed to make mashed potatoes, it does not blend egg white or any other cream for covering, it does not grind raw meat, it does not blend hard pastas and do not extract kernels from fruits and vegetables.

...process mixtures too long. Remember that the blender works in seconds and not in minutes. Therefore, never let your blender working for more than one minute. It is better to switch it off and check the mixing consistency after a few seconds to avoid too much blending.

... overload the motor with big or heavy portions as it will make the blender's life shorter. If motor stops, switch it off immediately, unplug and remove part of the load before to start operation again.

### **IMPORTANT**

**Do not use the blender to process products similar to “AÇAI dough “ Do not run the blender without a load, because irreparable damage will occur .**

## **3 - OPERATION**

### **3.1 – Starting**

Starting the Blender is achieved through keys No.01 and No. 03 (Pic.03) and the Timer Knob No 02 ( Pic. 03 ) placed on the motor housing .

The Timer Knob allows to choose the processing time span , between 10 and 45 seconds .

**Picture 03**

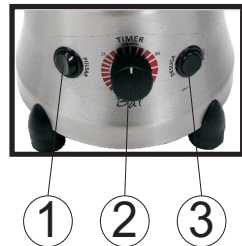

ON/OFF Switch No. 03 (Pic. 03) :

The first press onto the switch starts the selected time span, the blender will automatically stop when the time is over .

A second press will stop the blender during the time span .

Pulse switch No 01 ( Pic. 03 ) starts the blender and will keep it running as long as it remain pressed .

service company ("Service Company"). Products held at commercial facilities and weighing less than seventy (70) lbs. must be taken or shipped, shipping charges are prepaid, either to SKYFOOD's facility or to a Service Company. Mileage or travel time will NOT be paid. SKYFOOD offers a limited on-site warranty for products ONLY held at commercial facilities, whose net weight exceeds seventy (70) lbs., provided they are installed in a location that is within a thirty (30) mile radius of a Service Company. **End Users are responsible for all extra travel and mileage rates.** In this case, warranty services will be provided during regular business hours.

**This product will be replaced or repaired under warranty, for a period of (1) year, beginning from the date of purchase by the original purchaser/user ("End User").**

Accessories will be replaced or repaired under warranty, for a period of (30) days, beginning from the date of purchase by the original purchaser/user ("End User").

This warranty shall not take effect until a properly completed and executed **WARRANTY REGISTRATION** form has been received by SKYFOOD EQUIPMENT, LLC, within thirty (30) days from the date of purchase. The **WARRANTY REGISTRATION** is available either in the Instruction Manual of every Product or at SKYFOOD's website [www.skyfood.us](http://www.skyfood.us). The End User must fill out the **WARRANTY REGISTRATION** form and send it to SKYFOOD according to the instructions posted on the referred website. **Failure to do so will VOID the warranty.**

For questions or assistance, do not return the product or accessories to the store, please call Toll Free 1-800-503-7534 for Customer Support, or visit the Customer Service section of [www.skyfood.us](http://www.skyfood.us). For faster service please have the items name, serial number, and proof of purchase for the operator to assist you.

**SKYFOOD reserves the right to change the terms of its limited warranty at any time without any prior notice. It also reserves the right to change the design and specifications of its equipment or any related documentation at any time. The end user is not entitled to upgrades or refunds resulting from these changes.**

#### **Updates**

These **Terms and Conditions** were last updated on August 22<sup>th</sup>, 2011.

## SKYFOOD EQUIPMENT LLC - SERVICE

For questions or assistance with products **FLEETWOOD by SKYMSSEN** and **SKYMSSEN**, call SKYFOOD EQUIPMENT Toll Free : **1-800-503-7534**, 24h Customer support, or visit the Customer Service section of [www.skyfood.us](http://www.skyfood.us).

## SKYFOOD'S LIMITED WARRANTY

Unless otherwise specified, new **FLEETWOOD by SKYMSSEN** and **SKYMSSEN** products, excluding accessories, sold by SKYFOOD EQUIPMENT, LLC. ("SKYFOOD"), for use only in the continental United States (collectively, "Products" or singularly, "Product"), are warranted to be free from defects in materials and workmanship for a period of one (1) year from the date of purchase by the original purchaser/user ("End User"). Several new products and accessories may be warranted for a period other than one (1) year while others may be subject to travel limitations, as specified on the products Instruction Manual. **Proof of purchase must be presented; if not this warranty will be VOID.** No warranty is given or implied to a subsequent transferee or any other third party. This warranty is expressly conditional upon SKYFOOD being notified of any defects in materials or workmanship within five (5) days of its occurrence, within the warranted time period. If a notice of a claim under this warranty is timely made by the End User, SKYFOOD or a SKYFOOD's designated service company ("Service Company"), will repair or replace the Product, at SKYFOOD's discretion, subject to the additional conditions hereinafter described.

This warranty shall not apply if damage occurs from improper installation or maintenance performed by an unauthorized service company ("Service Company"), wrong voltage, nor to the extent that Products or parts have been used other than in conformance with operating and maintenance instructions, subjected to misuse or abuse or damaged by accident, acts of God, abnormal use, stress or any other matter unrelated to SKYFOOD, and beyond its reasonable control. **This warranty does NOT cover service labor and travel to perform adjustments on products and/or accessories.** In addition to wear and tear of certain items, such as, but not limited to; glass parts, blades, stones, chopper cutting knives, plates, slicing knives, cutting disc, gaskets, oil changes, sealing tape, heat seal wires, worm gears, self-lubricating bushings, carbon brushes for electric motors, and other parts expendable by nature and that need to be replaced frequently. **Electrical components are subject to natural wear and tear, and are NOT covered by this warranty. THIS WARRANTY EXCLUDES ALL ORAL, STATUTORY, EXPRESS OR IMPLIED WARRANTIES WHICH MAY BE APPLICABLE TO SKYFOOD, INCLUDING, BUT NOT LIMITED TO, ANY IMPLIED WARRANTY OF MERCHANTABILITY AND FITNESS FOR PARTICULAR PURPOSE.** Under no circumstances shall SKYFOOD be liable for loss of use, revenue or profit or for incidental or consequential damages. SKYFOOD shall under no circumstances be liable for any loss, damage, concealed damage, expense or delay of goods for any reason when said goods are in the custody, possession or control of third parties selected by SKYFOOD to forward, enter, clear, transport, or render other services with respect to such goods. The sole and exclusive remedy for breach of any warranty is limited to the remedies provided in the paragraph above.

All products held at non-commercial facilities or domiciles, must be taken or shipped, shipping charges prepaid, either to SKYFOOD's facility or a SKYFOOD's designated

## 3.2 – Feeding Procedure

These blenders work in high speed (approximately 18.000rpm).

To feed the blender proceed as follows:

- Cut the product in small pieces of up to 2cm size. This process helps on blending time mainly for frozen products. When triturating ice, it is recommended to drop some water inside the cup.
- Take out the lid No. 05 (Picture 02).
- Place the product to be processed into the cup No.04 (Picture - 02) with the
- machine switched OFF.
- Place the lid back No. 05 (Picture 02) and switch the machine ON.

## 3.3 CLEANING

The blenders cup parts are resistant to corrosion, hygienic and easily cleaned. Before using them for the first time and after each use, take apart the cup pieces (pic. 02) and clean them very well with warm clean water and neutral soap, wipe and dry them well.

**DO NOT WASH ANY PIECES IN A DISH WASHER.**

Revise all the pieces frequently before assembling them again. If the blades are stuck or turn with difficulty, **DO NOT USE THE BLENDER.** Do a review turning carefully the blades anti- clock-wise (the opposed edges are sharpened): The blades must move without difficulties.

Use only original SIEMSEN spare parts which are available at the Authorized Dealer.

**THE USAGE OF DAMAGED OR NOT RECOMMEND SPARE PARTS MAY CAUSE SERIOUS PERSONAL HURTS OR DAMAGES TO YOUR BLENDER.**

See on Page 03 (Pic. 02) all the steps to assemble the cup. **NEVER DIP THE MOTOR HOUSING IN WATER OR ANY OTHER LIQUID.** could be exposed to severe electrical shocks or even to a fatal situation.

### IMPORTANT:

**Always disconnected the machine from power source before cleaning**

Clean base external side with a wet cloth.

Motor has permanent lubrication and does not need any additional lubrication.

**ALL MAINTENANCE MUST BE DONE BY DEALERS TECHNICAL ASSISTANTS.**

### ATTENTION

**Keep the drain tube without obstructions.**

### 3.3.1 Cautions with Stainless Steel:

The Stainless Steel may present rust signs, which ARE ALWAYS CAUSED BY EXTERNAL AGENTS, especially when the cleaning or sanitization is not constant and appropriate.

The Stainless Steel resistance towards corrosion is mainly due to the presence of chrome, which in contact with oxygen allows the formation of a very thin protective coat. This protective coat is formed through the whole surface of the steel, blocking the action of external corrosive agents.

When the protective coat is broken, the corrosion process begins, being possible to avoid it by means of constant and adequate cleaning.

Cleaning must always be done immediately after using the equipment. For such end, use water, neutral soap or detergent, and clean the equipment with a soft cloth or a nylon sponge. Then rinse it with plain running water, and dry immediately with a soft cloth, this way avoiding humidity on surfaces and especially on gaps.

The rinsing and drying processes are extremely important to prevent stains and corrosion from arising.

**IMPORTANT**

**Acid solutions, saltern solutions, disinfectants and some sterilizing solutions (hypochlorites, tetravalent ammonia salts, iodine compounds, nitric acid and others), must be AVOIDED, once they cannot remain for long in contact with the stainless steel:**

These substances attack the stainless steel due to the CHLORINE on its composition, causing corrosion spots (pitting).

Even detergents used in domestic cleaning must not remain in contact with the stainless steel longer than the necessary, being mandatory to remove it with plain water and then dry the surface completely.

#### Use of abrasives:

Sponges or steel wool and carbon steel brushes, besides scratching the surface and compromising the stainless steel protection, leave particles that rust and react contaminating the stainless steel. That is why such products must not be used for cleaning and sanitization. Scrapings made with sharp instruments or similar must also be avoided.

#### Main substances that cause stainless steel corrosion:

Dust, grease, acid solutions such as vinegar, fruit juices, etc., saltern solutions (brine), blood, detergents (except for the neutral ones), common steel particles, residue of sponges or common steel wool, and also other abrasives.

<p>* <b>Vaciamiento del vaso.</b></p>	<p>* <b>Ausencia del anillo de vedamiento.</b></p> <p>* <b>Base del vaso floja.</b></p> <p>* <b>Problema en el empaque.</b></p>	<p>* <b>Coloque el anillo de vedamiento.</b></p> <p>* <b>Apriete la base del vaso.</b></p> <p>* <b>Llame la asistente Técnica.</b></p>
<p>* <b>El producto no se licua.</b></p>	<p>* <b>Pedazos muy grandes del producto impiden el contacto con la cuchilla.</b></p> <p>* <b>Cuchilla no afilada.</b></p>	<p>* <b>Corte el producto en pedazos menores, de aproximadamente 2cm..</b></p> <p>* <b>Llame la asistente Técnica.</b></p>

### 5.2 Diagrama eléctrico

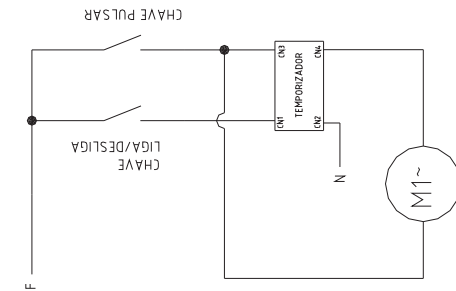

## 6. CONSEJOS GENERALES

- Do not wear loose fitting clothes while operating the unit. Do not use bracelets or any other piece of jewelry. Have your hair always shortened and held up (use hair fishnets if necessary) in a way it cannot reach any part of the machine. Roll up any loose sleeves.

- SKYMSSEN is not responsible for any harm or injury caused by the negligent or inappropriate use of this equipment by any operator. This equipment must be operated only by persons whose age equals or exceeds 18 years old, in a safe and sound state of mind, free from the influence of any kind of drugs and alcohol, that received proper training and instructions regarding the correct operation of this machine, that are wearing correct and authorized safety clothes. All and any kind of modifications carried on and applied to this machine immediately nullifies any kind of warranty and may result in harm and injuries to the individuals operating this machine and to individuals that are located in the machine surrounding areas while it is being operated.

- Under no circumstances place your hands in the moving parts of the machine while it is being used. Make sure the machine has come to a complete stop before accessing the processed ingredients.

## 4.6 Manutención

### 4.6.1 Peligros

Con la maquina ligada cualquier operación de manutención es peligrosa .  
**DESLÍGUELA FÍSICAMENTE DE LA RED ELÉCTRICA , DURANTE  
 TODA LA OPERACIÓN DE MANUTENCIÓN .**

## 4.7 Aviso

La manutención eléctrica o mecánica debe ser hecha por una persona calificada para hacer el trabajo .

La persona encargada por la manutención debe certificarse que la maquina trabaje bajo condiciones **TOTALES DE SEGURIDAD .**

## 5 Análisis y Resoluciones de Problemas

### 5.1 Problemas , causas y resoluciones .

Las Licuadoras Profesionales fueran diseñadas para necesitar un mínimo de manutención. Sin embargo pueden ocurrir algunas irregularidades en su funcionamiento debido al desgaste natural causado por su uso .

Caso ocurra algún problema verifique la Tabla 02 abajo donde están algunas soluciones recomendadas .

\* La vida de servicio - 2 años para la jornada de trabajo normal

**TABLA - 02**

Problemas	Causas	Soluciones
* La maquina no prende.	<p>* <b>Falta energía eléctrica o el enchufe está desconectado.</b></p> <p>* <b>Problema en el circuito interno o externo de la maquina.</b></p>	<p>* <b>Verifique si el enchufe está conectado, y si hay energía eléctrica.</b></p> <p>* <b>Llame la asistente Técnica.</b></p>

## 4. General Safety Practices

### IMPORTANT

**If any item from the GENERAL SAFETY NOTIONS section is not applicable to your product, please disregard it.**

The following safety instructions are addressed to both the operator of the machine as well as the person in charge of maintenance. The machine has to be delivered only in perfect conditions of use by the Distributor to the user. The user shall operate the machine only after being well acquainted with the safety procedures described in the present manual. **READ THIS MANUAL WITH ATTENTION.**

### 4.1 Basic Operation Practices

#### 4.1.1 Dangerous parts

Some parts of the electric devices are connected to high voltage points . These parts when touched may cause severe electrical shocks or even be fatal.

Never touch commands such as buttons, switches and knobs with wet hands , wet clothes and/or shoes. By not following these instructions operator could be exposed to severe electrical shocks or even to a fatal situation.

#### 4.1.2 Warnings

The operator has to be well familiar with the position of ON/OFF Switch to make sure the Switch is easy to be reached when necessary. Before any kind of maintenance, physically remove plug from the socket.

Provide space for a comfortable operation thus avoiding accidents. Water or oil spilled on the floor will turn it slippery and dangerous. Make sure the floor is clean and dry.

Before giving any manual command (switch, buttons, turn keys or lever) be sure the command is the correct one. Check this manual for further details if necessary.

Never use a manual command (switch, buttons, lever) unadvisedly.

If any work is to be made by two or more persons, coordination signs will have to be given for each operation step. Every step of the operation shall be taken only if a sign has been made and responded.

#### 4.1.3 Advices

In case of power shortage, immediately turn the machine OFF.

Use recommended or equivalent lubricants, oils or greases.

Avoid mechanical shocks as they may cause failures or malfunction.

Avoid penetration of water, dirt or dust into mechanical or electrical components of the machine.

DO NOT modify original characteristics of the machine.

DO NOT remove, tear off or maculate any labels stuck on the machine. If any label has been removed or is no longer legible, contact your nearest dealer for replacement.

**READ CAREFULLY AND WITH ATTENTION THE SAFETY OR OPERATION INSTRUCTIONS LABELS DISPLAYED ON THE MACHINE, AS WELL AS THE INSTRUCTION MANUAL AND THE TECHNICAL CHARACTERISTICS WRITTEN INSIDE**

## 4.2 Safety Procedures and Notes Before Switching Machine ON

### IMPORTANT

Carefully read ALL INSTRUCTIONS of this manual before turning the machine ON. Be sure to be familiar with the instructions and that you have well understood all information contained in this manual. If you have any question contact your supervisor or your nearest Dealer.

#### 4.2.1 Danger

An electric cable or electric wire with damaged jacket or bad insulation could cause electrical shocks as well as electrical leak. Before use, check conditions of all wires and cables.

#### 4.2.2 Advices

Be sure ALL INSTRUCTIONS in this manual have been thoroughly understood. Every function and operational procedure have to be very clear to the operator. Contact your nearest Dealer for further questions.

Any manual command (switch, button or lever) shall be given only after being sure it is the correct one.

#### 4.2.3 Precautions

The electric cable has to be compatible with the power required by the machine. Cables touching the floor or close to the machine need to be protected against short circuits.

Oil reservoir has to be full up to the required level as indicated. Check level and add oil if necessary.

## 4.3 Routine Inspection

#### 4.3.1 Advice

When checking the tension of the belts or chains, DO NOT introduce your fingers between the belts and the pulleys and nor between the chain and the gears.

#### 4.3.2 Precautions

Check if motors, belts, chains or gears and sliding or turning parts of the machine produce abnormal noises.

Check the tension of the belts and chains and replace the set when belt, chain or gears show signs of being worn out.

When checking tensions of belts or chain DO NOT introduce your fingers between belts and pulleys, nor between the chains and gears.

Check protections and safety devices to make sure they are working properly.

## 4.3 Inspección de Rutina

#### 4.3.1 Aviso

Al averiguar la tensión de las correas o de las cadenas , **NO** coloque los dedos entre las correas y las poleas, ni entre las cadenas y sus engranajes .

#### 4.3.2 Cuidados

Verifique los motores, correas, cadenas o engranajes y las partes deslizantes o girantes de la maquina , con relación a ruidos anormales .

Verifique la tensión de las correas o de las cadenas , y sustituya el conjunto , caso alguna correa, cadena o engranaje , tenga desgaste . Al verificar la tensión de las correas o de las cadenas , **NO** coloque los dedos entre las correas y poleas o entre las cadenas y engranaje .

Verifique las protecciones y los dispositivos de seguridad para que siempre funcionen adecuadamente .

## 4.4 Operación

#### 4.4.1 Avisos

No trabaje con pelo largo , que pueda tocar cualquier parte de la maquina , pues el mismo podría causar serios accidentes . Amarrelo para arriba y para atrás , o cubralo con un pañuelo .

Solamente operadores entrenados y calificados pueden operar la maquina .

Nunca toque con las manos o de cualquier otra manera , partes girantes de la maquina.

**JAMÁS** opere la maquina , sin algún de sus accesorios de seguridad.

## 4.5 Después de Terminar el Trabajo

#### 4.5.1 Cuidados

Siempre limpie la maquina . Para tanto , deslíguela físicamente del soquete .

Nunca limpie la maquina antes de su **PARADA COMPLETA**.

Recoloque todos los componentes de la maquina en sus lugares , antes de ligarla otra vez.

Al verificar la tensión de las correas o de las cadenas , **NO** coloque los dedos entre las correas y las poleas ni entre las cadenas i sus engranajes .

#### 4.1.3 Avisos

En el caso de falta de energía eléctrica, desligue inmediatamente la llave liga / desliga.

Use solamente óleos lubricantes o grasas recomendadas o equivalentes . Evite choques mecánicos , ellos pueden causar fallas o malo funcionamiento .

Evite que agua , suciedad o polvo entren en los componentes mecánicos y eléctricos de la maquina .

NO ALTERE las características originales de la maquina .

NO SUCIE , RASGUE O RETIRE CUALQUIER ETIQUETA DE SEGURIDAD O DE IDENTIFICACIÓN . Caso alguna esté ilegible o perdida, solicite otra al Asistente Técnico mas cercano .

LEA ATENTAMENTE Y CON CUIDADO LAS ETIQUETAS DE SEGURIDAD Y DE IDENTIFICACIÓN CONTENIDAS EN LA MAQUINA , ASÍ COMO LAS INSTRUCCIONES Y LAS TABLAS TÉCNICAS CONTENIDAS EN ESTE MANUAL .

#### 4.2 Cuidados y Observaciones Antes de Ligar la Maquina .

##### **IMPORTANTE :**

**Lea con atención y cuidado las INSTRUCCIONES contenidas en este Manual, antes de ligar la maquina . Certifíquese que entendió correctamente todas las informaciones . En caso de duda , consulte su superior o el Revendedor .**

#### 4.2.1 Peligro

Cables o hilos eléctricos con aislamiento dañado , pueden provocar choques eléctricos . Antes de usarlos verifique sus condiciones .

#### 4.2.2 Avisos

Esté seguro que las **INSTRUCCIONES** contenidas en este Manual, estén completamente entendidas . Cada función o procedimiento de operación y de manutención debe estar perfectamente claro .

El accionamiento de un comando manual ( botón, llave eléctrica, palanca, etc. ) debe ser hecho siempre después que se tenga la certitud de que es el comando correcto .

#### 4.2.3 Cuidados

El cable de alimentación de energía eléctrica de la maquina , debe tener una sección suficiente para soportar la potencia eléctrica consumida . Cables eléctricos que estuvieran en el suelo cerca de la maquina , deben ser protegidos para evitar corto circuitos.

#### 4.4 Operation

##### 4.4.1 Advice

Be sure your hair is not loose in order to avoid getting caught by turning parts which could lead to a serious accident. Tie your hair well up and/or cover your head with a scarf.

The operation performed by not trained or skilled personnel shall be forbidden.

Never touch turning parts with your hands or in any other way.

NEVER operate machine without all original safety devices under perfect conditions.

#### 4.5 After Finishing The Work

##### 4.5.1 Precautions

Always TURN THE MACHINE OFF by removing the plug from the socket before cleaning the machine. Never clean the machine unless it has come to a complete stop.

Put all components back to their functional positions before turning it ON again. Check level of oil. DO NOT place your fingers in between belts and pulleys nor chains and gears.

#### 4.6 Maintenance

##### 4.6.1 Danger

Any maintenance with the machine in working situation is dangerous. TURN IT OFF BY PULLING THE PLUG OFF THE SOCKET DURING MAINTENANCE.

#### 4.7 Advice

Electrical or mechanical maintenance must be done by qualified personnel for such operation.

Person in charge has to be sure that the machine is under TOTAL SAFETY conditions when working.

### 5. PROBLEMS ANALYSIS and SOLUTIONS

#### 5.1 Problems, Causes and Solutions

The Professional Blenders have been designed to need minimum maintenance. However, some performance failures may happen due normal wear during the machine lifetime.

If some problem arises with your Professional Blenders , check Table - 02 as follows, where there are detailed some recommended possible solutions.

\* Service life – 2 years for regular work shift

TABLE - 02

Problem	Causes	Solutions
* The machine does not switch On.	* Lack of power or the plug is off its socket.  * Problem with the internal or external electric circuit of the machine.	* Check if the plug is on its socket, and if there is electric power.  * Call technical assistance.
* Cup is leaking.	* There is no rubber Sealing ring.  * Cup base is not properly fixed.  * Problems in the sealing system.	* Place the rubber sealing ring.  *Tighten the cup base.  * Call technical assistance.
*The processed product inside the cup does not blend.	* The product is to big not allowing the contact with the blade.  * Blunt Blade.	* Cut the ingredientes to pieces smaller than 2 cm size.  * Call technical assistance.

## 4 Nociones Generales de Seguridad

### IMPORTANTE

En el caso de algun item de las NOCIONES GENERALES DE SEGURIDAD no ser aplicable en su producto, por favor desconsiderar el mismo.

Las Nociones Generales de Seguridad fueran preparadas para orientar y instruir adecuadamente a los operadores de las maquinas, así como aquellos que serán responsables por su manutención.

La maquina solamente debe ser entregue al operador en buenas condiciones de uso, al que el operador debe ser orientado cuanto al uso y a la seguridad de la maquina por el Revendedor. El operador solamente debe usar la maquina con el conocimiento completo de los cuidados que deben ser tomados, después de LER ATENTAMENTE TODO ESTE MANUAL.

### 4.1 Practicas Básicas de Operación

#### 4.1.1 Peligros

Algunas partes del accionamiento eléctrico presentan pontos o terminales con altos voltajes. Cuando tocados pueden ocasionar graves choques eléctricos, o hasta la muerte de una persona.

Nunca toque un comando manual ( botón, llave eléctrica, palancas etc. ) con las manos, zapatos o ropas mojadas. No obedecer esta recomendación, también podrá provocar choques eléctricos, o hasta la muerte de una persona.

#### 4.1.2 Advertencias

El local de la llave liga / desliga debe ser bien conocido, para que sea posible accionarla a cualquier momento sin la necesidad de procurarla.

Antes de cualquier manutención desconecte la maquina de la red eléctrica.

Proporcione espacio suficiente para evitar caídas peligrosas.

Agua o aceite podrán hacer resbaloso y peligroso el piso. Para evitar accidentes el piso debe estar seco y limpio.

Antes de accionar cualquier comando manual ( botones , llaves eléctricas , palancas , etc. ) verifique siempre si el comando es el correcto , o en caso de dudas , consulte este Manual .

Nunca toque ni accione un comando manual ( botones , llaves eléctricas , palancas etc. ) por acaso .

Si un trabajo debe ser hecho por dos o más personas , señales de coordinación deben ser dados antes de cada operación . La operación siguiente no debe ser comenzada sin que la respectiva señal sea dada y respondida .

### 3.3.1 Cuidados con los aceros inoxidables

Los aceros inoxidables pueden presentar puntos de “herrumbre”, que SIEMPRE SON PROVOCADOS POR AGENTES EXTERNOS, principalmente cuando el cuidado con la limpieza o higienización no sea constante y adecuado.

La resistencia a la corrosión del acero inoxidable se debe principalmente a la presencia del cromo que, en contacto con el oxígeno, permite la formación de una finísima camada protectora. Esta camada protectora se forma sobre toda la superficie del acero, bloqueando la acción de los agentes externos que provocan la corrosión.

Cuando la camada protectora sufre un rompimiento, el proceso de corrosión es iniciado, pudiendo ser evitado a través de una limpieza constante y adecuada.

Inmediatamente después de la utilización del equipamiento, es necesario proceder con la limpieza, utilizando agua, jabón o detergentes neutros, aplicados con un paño suave o esponja de nylon. A seguir, solamente con agua corriente, se debe enjuagar e, inmediatamente secar, con un paño suave, evitando la permanencia de humedad en las superficies y principalmente en las grietas.

El enjuague y el secado son extremadamente importantes para evitar el apareamiento de manchas o corrosiones.

#### IMPORTANTE

**Soluciones ácidas, soluciones salinas, desinfectantes y determinadas soluciones esterilizantes (hipocloritos, sales de amoníaco tetravalente, compuestos de iodo, ácido nítrico y otros), deben ser EVITADAS por no poder permanecer mucho tiempo en contacto con el acero inoxidable:**

Visto que generalmente poseen CLORO en su composición, tales sustancias atacan el acero inoxidable, causando puntos de corrosión.

Mismo los detergentes utilizados en la limpieza doméstica, no deben permanecer en contacto con el acero inoxidable más de lo necesario, debiendo ser también removidos con agua y la superficie deberá ser completamente seca.

#### Uso de abrasivos:

Esponjas o estropajos de acero y cepillos de acero en general, además de rallar la superficie y comprometer la protección del acero inoxidable, dejan partículas que oxidan y reaccionan, contaminando el acero inoxidable. Por eso, tales productos no deben ser usados en la limpieza e higienización. Raspados hechos con instrumentos puntiagudos o similares también deberán ser evitados.

#### Principales sustancias que causan la corrosión de los aceros inoxidables:

Polvos, engrases y soluciones ácidas como el vinagre, sucos de frutas u otros ácidos, soluciones salinas (salmuera), sangre, detergentes (excepto los neutros), partículas de aceros, residuos de esponjas o estropajos de acero común, además de otros tipos de abrasivos.

## 5.2 Electrical Diagram

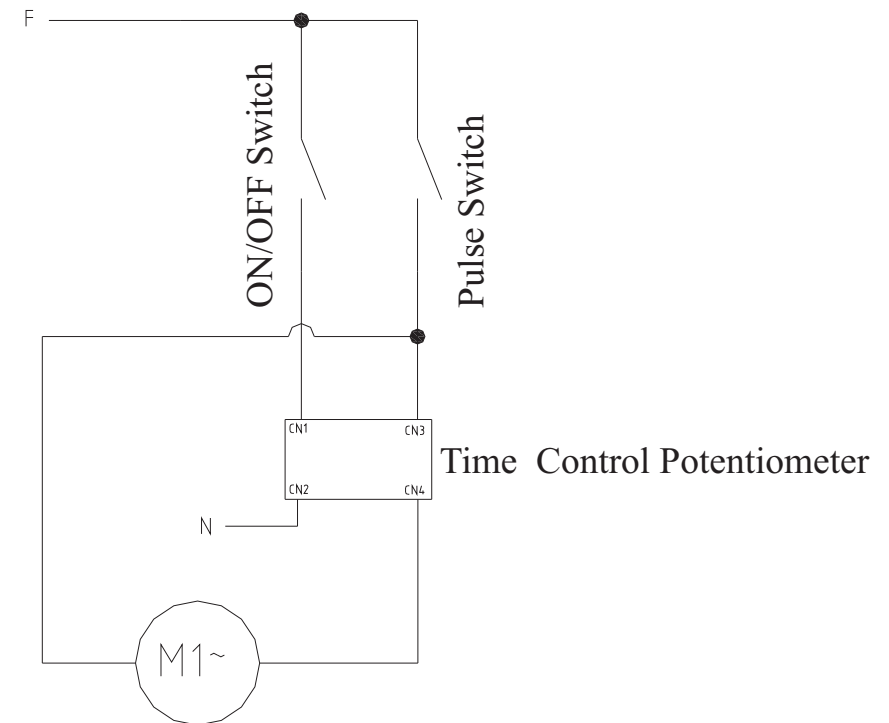

## 6. GENERAL ADVICES

- Do not wear loose fitting clothes while operating the unit. Do not use bracelets or any other piece of jewelry. Have your hair always shortened and held up (use hair fishnets if necessary) in a way it cannot reach any part of the machine. Roll up any loose sleeves.

- SKYMSSEN is not responsible for any harm or injury caused by the negligent or inappropriate use of this equipment by any operator. This equipment must be operated only by persons whose age equals or exceeds 18 years old, in a safe and sound state of mind, free from the influence of any kind of drugs and alcohol, that received proper training and instructions regarding the correct operation of this machine, that are wearing correct and authorized safety clothes. All and any kind of modifications carried on and applied to this machine immediately nullifies any kind of warranty and may result in harm and injuries to the individuals operating this machine and to individuals that are located in the machine surrounding areas while it is being operated.

- Under no circumstances place your hands in the moving parts of the machine while it is being used. Make sure the machine has come to a complete stop before accessing the processed ingredients.

# ÍNDICE

<b>1. Introducción</b>	<b>14</b>
1.1 Seguridad	14
1.2 Componentes Principales	15
1.3 Características Técnicas	15
<b>2. Instalación y Pre-Operation</b>	<b>16</b>
2.1 Instalación	16
2.2 Procedimiento para montar el vaso de la licuadora	16
2.3 Pre-Operation	16
<b>3. Operación</b>	<b>17</b>
3.1 Accionamiento	17
3.2 Procedimientos para utilización	18
3.3 Limpieza	18
<b>4. Nociones Generales de Seguridad</b>	<b>20</b>
4.1 Practicas Basicas de Operación	20
4.2 Cuidados y Observaciones Antes de Prender la Maquina	21
4.3 Inspección de Rutina	22
4.4 Operación	22
4.5 Después de Terminar el Trabajo	22
4.6 Mantenimiento	23
4.7 Avisos	23
<b>5. Análisis y Resoluciones de Problemas</b>	<b>23</b>
5.1 Problemas, Causas y Soluciones	23
5.2 Diagrama Eléctrico	24
<b>6. Consejos Generales</b>	<b>24</b>

- Llave Prende/Desliga N°03 (Fig.03).
- Al presionar una vez la Llave Prender, se iniciará el ciclo elegido y, la máquina desligará automáticamente cuando alcance el término del ciclo previamente seleccionado.
- Si desea interrumpir el ciclo previamente elegido, antes del fin del tiempo elegido, presione nuevamente la Llave Prender y el ciclo de operación será interrumpido a cualquier momento.  
La llave Pulsar N°01 (Fig.03) tiene la función solamente de Pulso y la maquina quedará en funcionamiento hasta cuando esta tecla esté presionada.

**IMPORTANTE**  
**En cualquier caso de emergencia, desconecte el enchufe de la toma de corriente eléctrica.**

## 3.2 Procedimiento para utilización

Ésta licuadora es una máquina que trabaja en alta velocidad, aproximadamente 18.000 rpm.

Para alimentar el vaso, proceder como sigue :

- corte el producto en trozos pequeños de aproximadamente 2cm. Este procedimiento ayuda en el proceso, principalmente si el producto está congelado.
- para la trituration de hielo, recomendamos agregar un poco de agua.
- sacar la tapa Nr.05 (Fig.02) del vaso
- colocar el producto en el vaso Nr.04 (Fig.02) con la máquina desligada.
- colocar la tapa Nr.05 (Fig.02) y prender la máquina.

## 3.3 Limpieza

Las partes del vaso de la licuadora son resistente a corrosión, son higiénicas y de fácil limpieza. Antes de utilizarla por primera vez y luego después de cada uso, separe las partes del vaso ( Fig.02 ) y límpielas muy bien con agua y jabón líquido neutro., luego enjuagar y secar.

Limpie también el gabinete del motor con un trapo húmedo.

**NO LAVE NINGUNA PARTE EN UNA MAQUINA LAVADORA.**

Utilice solamente partes originales SKYMSEN, las cuales están a disposición en los Distribuidores Autorizados.

**LA UTILIZACIÓN DE REPUESTOS DAÑADOS O NO RECOMENDADOS PODRÁ CAUSAR GRAVES DAÑOS PERSONALES Y/O DAÑOS A SU LICUADORA. NUNCA SUMERJA LA MAQUINA EN AGUA U OTRO LIQUIDO. TODO SERVICIO DE MANTENIMIENTO DEBE SER EFECTUADO POR LOS DISTRIBUIDORES AUTORIZADOS SKYMSEN.**

No utilice la licuadora si está con las cuchillas que no giran. Haga una revisión antes de prenderla a la toma de corriente: gire cuidadosamente la cuchilla en dirección ante horario (cuidado pues los bordes opuestos son afilados). Las cuchillas deben moverse sin dificultad.

El motor posee lubricación permanente, así que no requiere cualquier lubricación.

**ATENCIÓN**

**Mantener el tubo de drenaje desobstruido**

Colocar en el vaso, primero el líquido de la receta y después los sólidos, a menos que la receta indique lo contrario.

Cortar todas las frutas o legumbres y verduras, así como también las carnes cocinadas y pescado en porciones de 2cm. Cortar los quesos en porciones de máximo 1,5cm.

Cuando necesario, utilice una espátula de silicona o de goma para mezclar los ingredientes con el líquido. SOLAMENTE cuando la máquina esté desligada de la toma de corriente.

Colocar la tapa firmemente en el vaso, antes de prender la licuadora y mantener la mano sobre la tapa hasta que el motor esté en funcionamiento.

Retirar las salsas espesas, la manteca, mayonesa o productos de consistencia semejante, removiendo el vaso del gabinete del motor de la licuadora y empujándolos por la abertura inferior del vaso .

### NO SE PUEDE:

...esperar que su Licuadora sustituya los artefactos de la cocina.

...esta licuadora no hace puré de papas o de legumbres, no hace claras en nieve ni sustitutos para coberturas de cremas.

...tampoco pica carne cruda y no mezcla masas duras, ni extrae pepitas, huesos, semillas de frutas, legumbres o verduras.

...procesar las recetas o mezclas por mucho tiempo. Esta licuadora realiza los procesos en segundos NO en minutos. Así que el tiempo de los procesos deben siempre ser inferiores a un minuto. Si tiene dudas si la mezcla alcanzó el punto que desea, es mejor desligar la máquina luego de algunos segundos y verificar su consistencia.

...SOBRECARGAR el motor con porciones muy pesadas o muy grandes, pues de esta forma será disminuida la vida útil de la licuadora. Si el motor parar, desligar inmediatamente la máquina, desconectando el enchufe de la toma de corriente y sacar un poco de los ingredientes, para entonces volver a prender la Licuadora.

## 3 OPERACIÓN

### 3.1 Accionamiento

El accionamiento de la maquina es hecho a través de las teclas N°01 Llave Prende/Desliga y N°03 Llave Pulsar, ambas (Fig.03) y, del Variador de Tiempo, botón rotativo N°2 (Fig.03), existente en la parte frontal del gabinete de la maquina.

El Variador de Tiempo N°02 (Fig.03) tiene la función de seleccionar el tiempo de procesamiento de los alimentos, que puede estar entre 10 y 45 segundos.

Figura.03

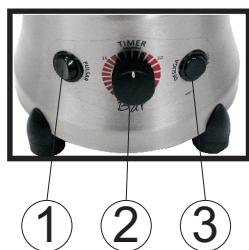

## 1 . Introducción

### 1.1 Seguridad

**Al usar las licuadoras profesionales rogamos fijarse en algunas precauciones básicas de seguridad :**

- 1.1.1 Lea todas las instrucciones ,
- 1.1.2 Para evitar el riesgo de choques eléctricos, y daños al equipo, nunca lo use sobre superficies húmedas o mojadas , ni las inmerja en agua o otro líquido
- 1.1.3 Cualquier equipo debe ser supervisado cuando usado cerca de niños .
- 1.1.4 Desconecte el equipo cuando no sea usado , antes de limpiarlo o antes de remover accesorios .
- 1.1.5 Evite el contacto con piezas en movimiento.
- 1.1.6 No use el equipo cuando tenga el cable de alimentación o la enchufe dañados.
- 1.1.7 Tampoco no lo use cuando el equipo no estea funcionando correctamente o cuando haya sufrido una caída , o se haya dañado de cualquier manera . Si algo se pasara lleve su equipo a la Asistencia Técnica para su revisión, reparo o ajuste mecánico o eléctrico .
- 1.1.8 Mantenga las manos o cualquier otro utensilio lejos del equipo mientras en funcionamiento para evitar daños a la persona o al equipo . Si fuera necesario mezclar , etc. , desprenda y desconecte la licuadora e use una espátula de goma .
- 1.1.9 Las cuchillas son muy afiladas , tenga cuidado al tocarlas .
- 1.1.10 Para evitar riesgo de danos corporales , nunca coloque en la maquina el cojinete central con la cuchilla , sin que el vaso esté debidamente encajado y firmemente atornillado .
- 1.1.11 Atornille firmemente la base del vaso. Caso contrario habría riesgo de lesión corporal si accidentalmente la cuchilla estuviera expuesta y la maquina prendida .
- 1.1.12 Siempre coloque la tapa en el vaso antes de prender el equipo .
- 1.1.13 Agarre el vaso mientras la licuadora estuviera funcionando. Si el vaso se suelta, desprenda la maquina inmediatamente . Saque el producto de adentro el vaso y atornille el vaso firmemente .
- 1.1.14 Al trabajar con líquidos calientes, retire la sobre tapa transparente de la tapadle vaso y mantenga las manos lejano del agujero , evitando posibles quemaduras .
- 1.1.15 No use el equipo al aire libre
- 1.1.16 No permita que el cable de alimentación se quede en la borda de la mesa , ni que toque superficies calientes .
- 1.1.17 No deje la licuadora funcionar sin supervisión .
- 1.1.18 Desprenda la licuadora de la red eléctrica cuando desee limpiarla, hacer manutención o otro servicio cualquiera .
- 1.1.19 Nunca use instrumentos que no hagan parte de la licuadora para auxiliar en su operación .
- 1.1.20 Nunca use chorros de agua directamente sobre la maquina .
- 1.1.21 Nunca prenda la maquina con ropas o zapatos mojados .
- 1.1.22 Para su seguridad, la temperatura de los productos procesados no deberá superar los 40° Celsius / 104° Fahrenheit.



## 1.2 Componentes Principales

Todos los componentes que incorporan la maquina son construidos con materiales cuidadosamente seleccionados para su función, dentro de los padrones de prueba y de la experiencia de SIEMSEN.

- 01 – Vaso
- 02 – Tapa del Vaso
- 03 – Gabinete
- 04 – Llave Prende/Desliga
- 05 – Tapa menor
- 06 – Variador de tiempo
- 07 – Llave Pulsar

FOTO-01



## 1.3 Características Técnicas

Tabla - 01

CARACTERÍSTICA	Unidad	LI-2,0BAR
Tensión	[V]	110 ou 220 *
Frecuencia	[Hz]	50 / 60
Potencia	[W]	800
Consumo	[kW/h]	0,8
Altura	[mm]	420
Ancho	[mm]	200
Profundidad	[mm]	200
Peso Neto	[kg]	2,5
Peso Bruto	[kg]	3,0
Capacidad Máxima del Vaso	[L]	2,0
Rotación	[ rpm]	18000

(\*) La tensión será única de acuerdo a la del motor de la maquina.

## IMPORTANTE

Metalurgica Siemens Ltda.. NO SE RESPONSABILIZA por daños causados a los equipos por el empleo de componentes que no sean originales .

## 2 . Instalación y Pre- Operación

### 2.1 Instalación

Trabaje con su Licuadora Profesional sobre una superficie estable preferentemente con 850 mm de altura .

Estes equipos furan diseñados par 110V o 220V ( 50 /60 HZ ) . Al recibir la licyadora verifique el voltaje indicado en la etiqueta existente en el cable de alimentación eléctrica . El enchufe del canle posee 2 claveles rectangulares y un clavel redondo que es el hilo tierra . Es obligatorio que los claveles sean debidamente conectados antes de prender el equipo .

### 2.2 Procedimiento para montar el vaso de la Licuadora

2.2.1 - Coloque la Goma de Vedamiento No. 01 sobre el Cojinete Central No. 02 Fig (02)

2.2.2 – Encaje el Cojinete Central No 02 Fig. (02) con la Goma de Vedamiento No 01 Fig (02) en la Base del Vaso No.03 Fig (02) .

2.2.3 – Atornille el Vaso No 04 Fig (02) en la Base del Vaso N 03 Fig (02) .

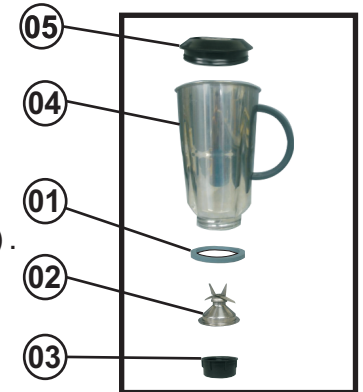

### 2.3 Pre-Operación

Lo que se puede hacer o no se puede hacer con su licuadora profesional :

### SE PUEDE

Utilizar solamente el voltaje especificado en la etiqueta ubicada en la parte trasera de la Licuadora.

Siempre operar la Licuadora en una superficie limpia y seca, para evitar que el aire pueda incluir sustancias raras o agua en el motor.